

version .1

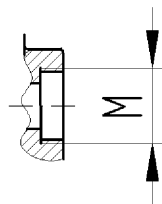
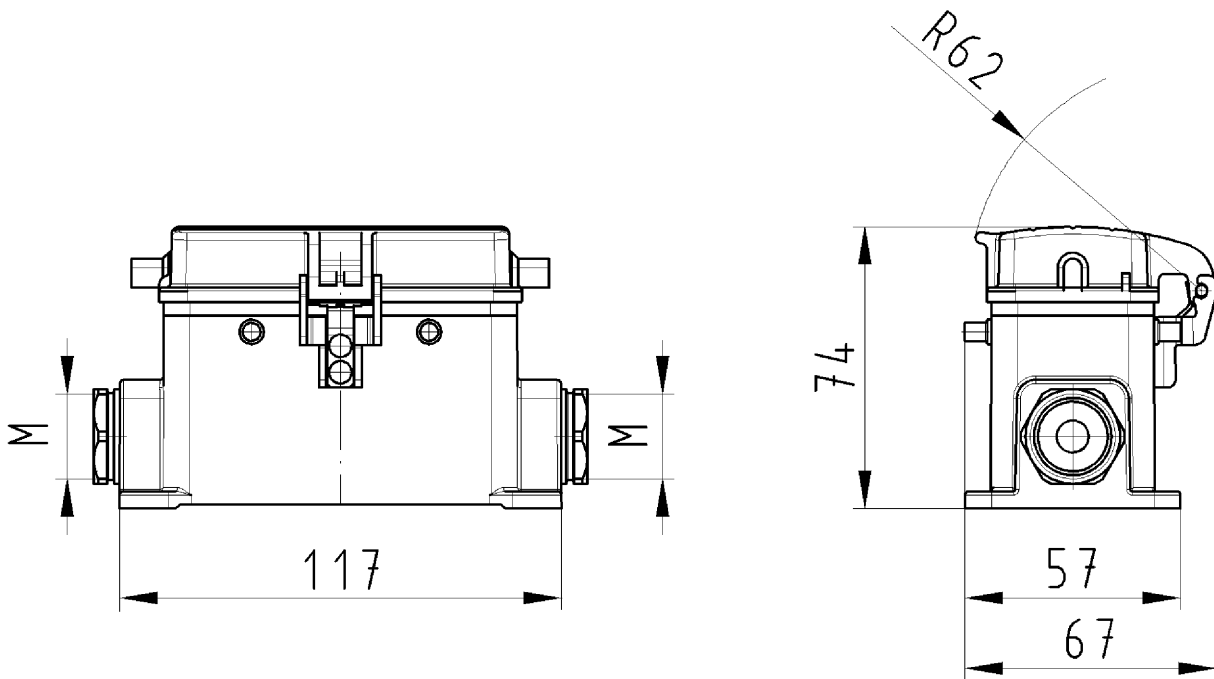

version .1

Gehäuseunterteil  
70.340.1635.0  
72.340.1635.0

Zeichnungsnummer  
70.340.1635.010W  
Gehäuseunterteil

21.11.2007  
Roppelt Dominik  
M 1:1